

creative since 1965
the modular icon by
Fritz Haller & Paul Schärer

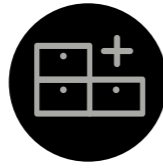

Home



Online Configurator
Design your individual piece of USM and order online or at one of our salespartners.

www.usm.com



Customized Service
Visit a USM Showroom or one of our 400 international sales partners worldwide for individual support. Find your closest USM professional online.

www.usm.com



Price list
Scan the QR code to go to the price list.

- 4 Living room
- 14 Dining
- 20 Entertainment
- 28 Bedroom
- 34 Kids
- 38 Shelving
- 48 Storage
- 58 Home office

The USM world

- 68 USM and sustainability
- 70 Product information
- 80 Colours & surfaces

Home is our personal retreat, the private space where we share special time with family and friends.

It is a reflection of our lifestyle, our attitudes and the things that mean the most to us. As our lives and tastes change, our home evolves with us – always in sync with our current needs.

USM Modular Furniture is designed to accompany us through different phases of life. It adjusts to new demands, ready to take up different functions in our home.

USM Haller is the epitome of timeless design: almost 60 years ago, Fritz Haller and Paul Schärer created a completely new aesthetic – a furniture system inspired by architecture.

Two visionaries, one idea

After completing his engineer studies, Paul Schärer Jr. joined the family business in 1961. The engineer had big ideas: he wanted to build a modern, industrial factory. He partnered with Fritz Haller, a respected architect of Solothurn school.

Born from architecture

Haller developed a flexible construction system with various steel modules. This inspired Paul Schärer Jr., who had a bigger vision: interior design that complements architecture. Together, they developed a modular piece of furniture that was predestined for further development.

Furniture with a system

The centrepiece of the system is a chrome-plated ball with six threaded holes. It connects the chrome-plated steel tubes in any combination. Finally, add sheet steel panels, which are powder-coated in various colours. Everything was intended for the company's own offices.

From prototype to USM Haller

When photos of the forward-thinking furniture system with its innovative aesthetics appeared in architecture journals, it was hailed an international sensation. A commission came from the Rothschild bank in Paris consisting of 600 workstations – the company's first major project. Series production began in 1969.

Less is more

With endless possibilities, the USM Haller system can be configured at will and adjusted to changing requirements, in all directions. Its strikingly fascinating minimalism is eye-catching and inspiring for everyone who values design, quality and functionality.

Modern art

An icon of modern design, USM Haller has been on display at the MoMA in New York since 2001 and recognised as a 'work of applied art' since 1988. USM Haller continues to evolve, while remaining true to itself by retaining original characteristics and invites users to challenge their own creativity.

From Münsingen out into the world

Alexander Schärer has headed up this fourth-generation family business since 2000. Production is still carried out at the headquarters in Münsingen. USM employs 450 people and currently has subsidiaries in the USA, France, Germany, UK, Japan and China. USM products are distributed by dealers in over 40 countries. Sustainability has always been a top priority. In 2008, USM was awarded Greenguard environmental certification and received the Cradle-to-Cradle® environmental label in 2018. The vision is to become a fully circular company by 2030. → S. 68

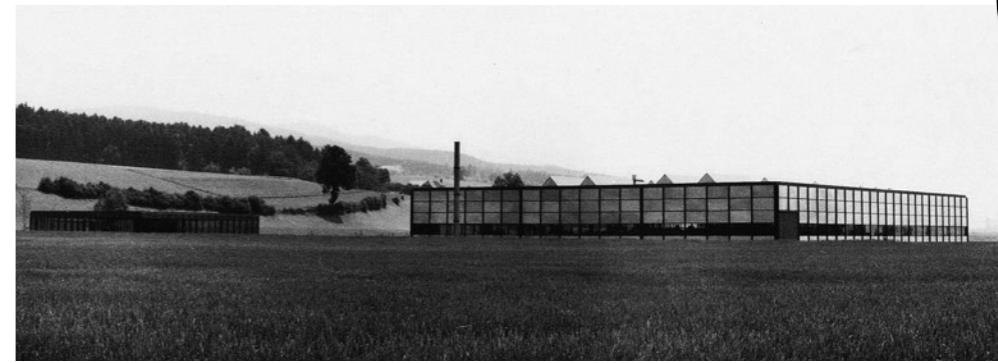

- 1 New factory (1963) and office pavilion (1965) in Münsingen, designed by Fritz Haller.
- 2 In 1965, USM Haller was developed to furnish personal use workspaces within visionary architecture.
- 3 Schärer family home (1969), designed by Fritz Haller, furnished with USM Haller.
- 4 The key to space. Balls, tubes, panels: what began 60 years ago continues to inspire today.

the modular icon by
Fritz Haller & Paul Schärer,
Switzerland

f. haller paul schärer



Living room

It is simply about living your ideas, your style.

Make your home personal. Clear lines, versatile modularity: USM Haller lets you decide. Unobtrusive but essential, it adapts to your lifestyle, your changing needs, your personal taste. A lasting companion for life, from one generation to the next.

1 Sideboard
W/D/H: 2273/523/430 mm
with one extension door
and castors

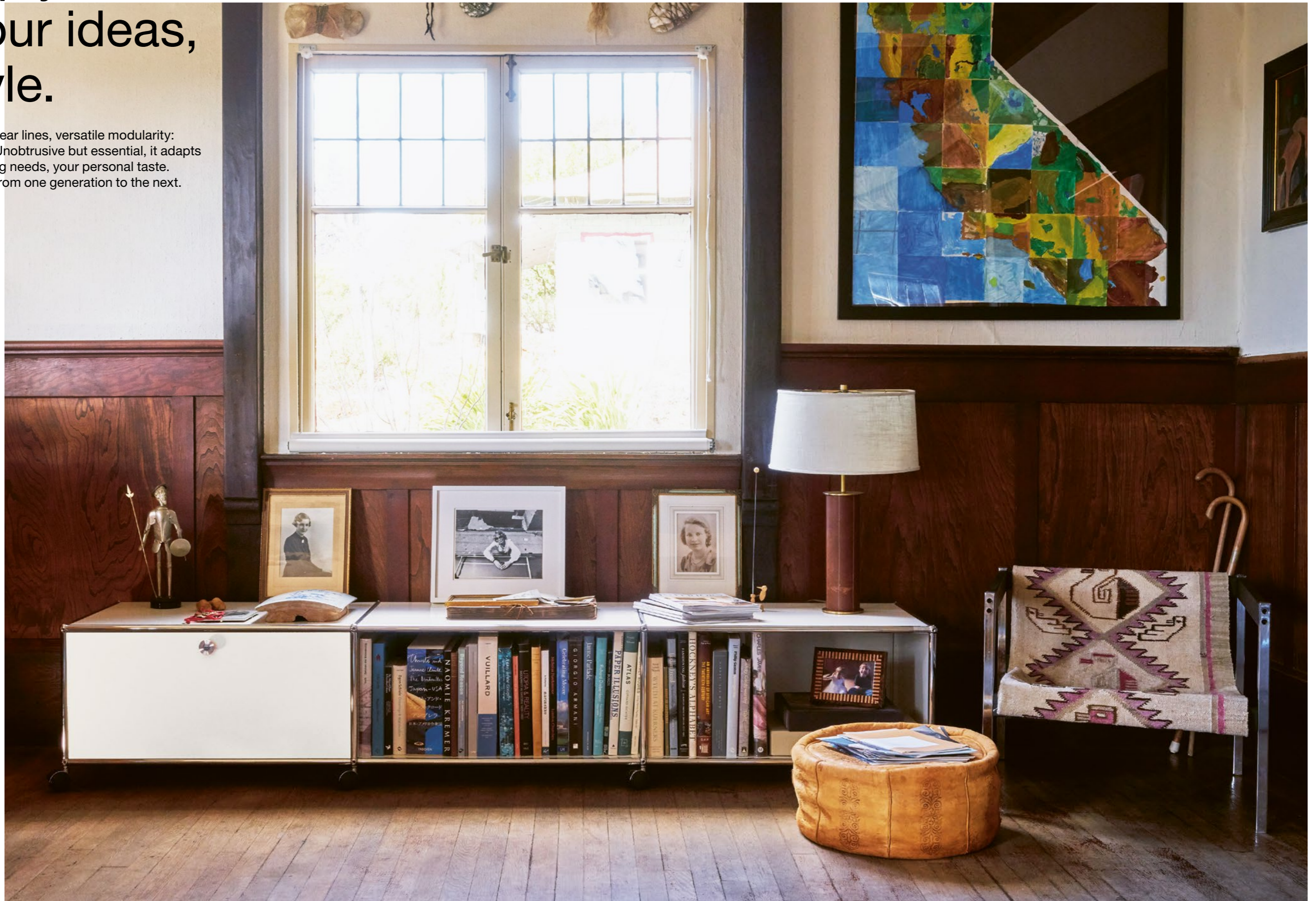

Living room



- ↙
- 2 Sideboard
W/D/H: 2273/373/740 mm
with three drop-down doors
-
- 3 Media unit with built-in
USM Haller E lighting*
W/D/H: 1523/373/390 mm
with two drop-down doors
- * with a dimmable cold or
warm white light



- 4 Sideboard
W/D/H: 1523/373/740 mm
with four drop-down doors
- 5 Sideboard
W/D/H: 2273/373/740 mm
with two drop-down doors
and one extension door
with box insert
- 6 Sideboard
W/D/H: 3773/373/740 mm
with three drop-down doors
and three extension doors

Living room



7 Glass showcase with built-in USM Haller E lighting*
W/D/H: 773/523/1090 mm with three glass doors
*with a dimmable cold or warm white light

8 Glass showcase
W/D/H: 3023/373/740 mm with eight glass doors



9 Glass showcase
W/D/H: 1523/373/740 mm with four glass doors



10 USM Haller side table, square
L/D/H: 750/750/370 mm
Brown oiled oak veneer



11 Sideboard
W/D/H: 1023/1023/540 mm



12 Side table
W/D/H: 523/373/390 mm with one fixed shelf

Living room



Create the colour combination of your dreams with our configurator.
www.usm.com

↙
13 Storage unit
W/D/H: 2273/1518/740 mm
with six drop-down doors
and one drawer

↓
14 Storage unit
W/D/H: 3623/373/2140 mm
with one drop-down door,
one flip-up door, three extension
doors with box insert and
a world of plants



Living room

↓
15 Side table
W/D/H: 723/723/390 mm

↘
16 Shelving
W/D/H: 3673/373/2490 mm
with nine drop-down doors

↘
17 Side table
W/D/H: 523/523/435 mm



Dining

Sharing time together with family and friends is priceless.

It is often little things that make life richer. Spending time with loved ones, eating, talking, laughing together. All it takes is a large table to gather around. Pure and simple in design, the USM Haller Table allows you to dine in style.

18 USM Haller table,
rectangular
L/D/H: 2000/1000/740 mm
transparent glass

19 Showcase with built-in
USM Haller E lighting*
W/D/H: 2523/373/1865 mm
with four extensions doors
and eight glass doors
*with a dimmable cold or
warm white light



Dining



↙
 20 Shelving
 W/D/H: 2123/373/1315 mm
 with three drop-down doors,
 three extension doors with box
 inserts, two glass doors and
 a world of plants

↙
 21 USM Haller table,
 rectangular
 L/D/H: 1750/1000/740 mm
 transparent glass

↙
 22 Shelving
 W/D/H: 3773/523/665 mm
 with five drop-down doors
 and five extension doors
 with box inserts



23 Shelving
 W/D/H: 1523/373/1090 mm
 with four drop-down doors



24 Shelving
 W/D/H: 2273/373/1315 mm
 with seven drop-down doors
 and two extension doors
 with box insert



25 Coffee trolley
 W/D/H: 1023/523/1126 mm
 with pull handle, one extension
 door with box insert, two drop
 down doors, one divider shelf,
 two USM Inos boxes and castors

Dining



26 Kitchen trolley
W/D/H: 773/523/675 mm
with a world of plants
and castors

27 Shelving
W/D/H: 2523/373/1560 mm
with twelve drop-down doors
and two glass doors



28 Sideboard
W/D/H: 1523/373/740 mm
with two drop-down doors



29 Sideboard
W/D/H: 2273/373/640 mm
with three drop-down doors



30 USM Haller table,
rectangular
L/D/H: 1750/750/740 mm
Pastel grey laminate



31 Serving trolley
W/D/H: 773/523/575 mm
with a pull handle and castors

Trends come and go while classic design is constant.

Clean in shape, honest in materialisation, timeless in design – USM Haller exists beyond trends. The beat of your life might change from time to time, another must-have home gadget might arrive. USM stays and adapts.

32 Media unit with built-in USM Haller E lighting*
W/D/H: 3373/373/1440 mm
with a world of plants, four extension doors and one drop-down door
*with a dimmable cold or warm white light

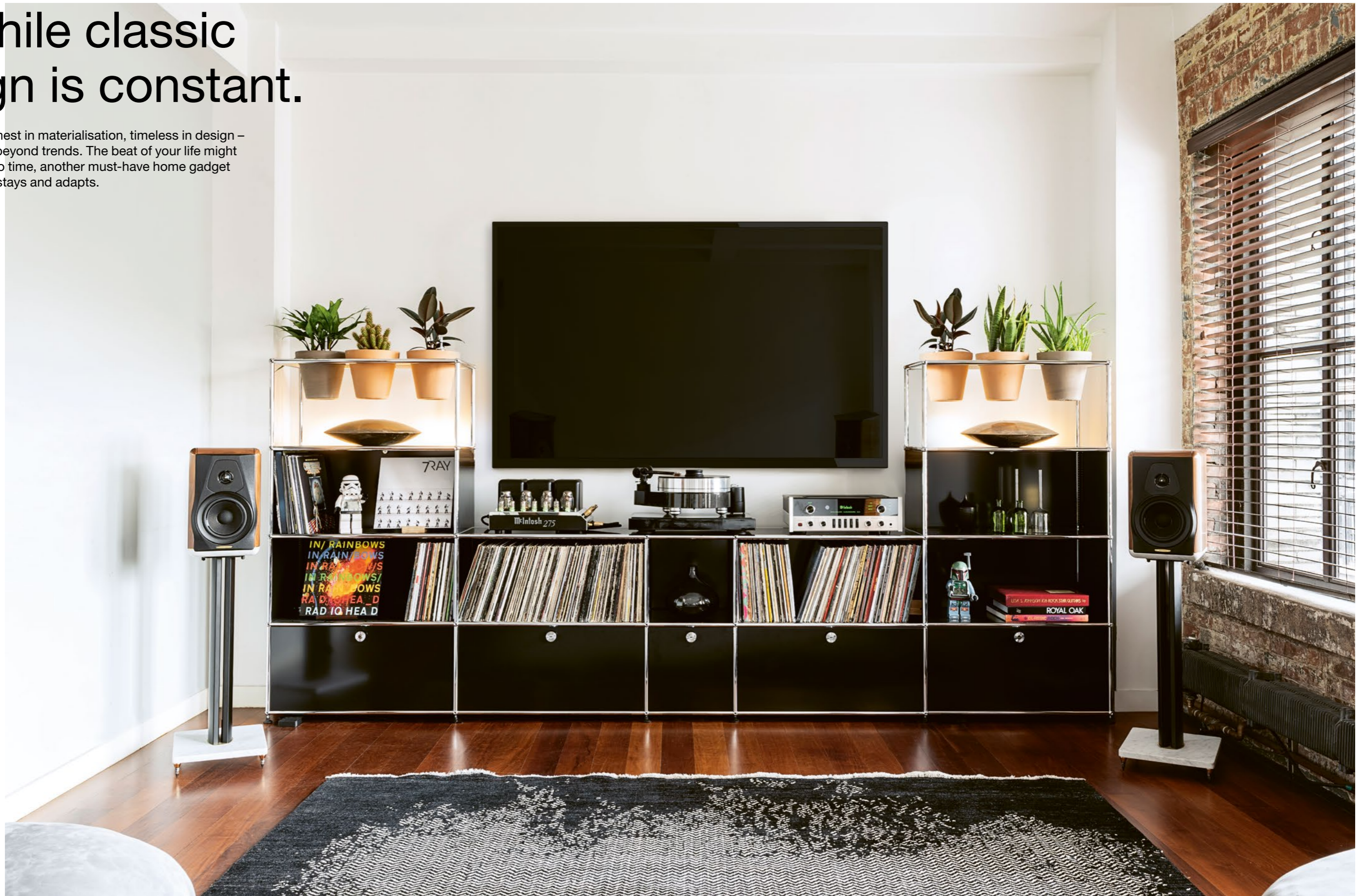

Entertainment



33 Sideboard
W/D/H: 2273/373/740 mm
with three extension doors

34 Sideboard
W/D/H: 1273/373/740 mm
with two drop-down doors
and a world of plants



35 Sideboard
W/D/H: 1523/373/565 mm
with four drop-down doors



36 Sideboard
W/D/H: 1523/373/740 mm
with two drop-down doors



37 Low mobile
TV/HiFi unit
W/D/H: 1523/373/430 mm
with two divider shelves,
cable cut-out and castors



38 Low mobile
TV/HiFi unit
W/D/H: 1523/373/430 mm
with two drawers and castors

39 Sideboard
W/D/H: 2023/523/740 mm
with one drop-down door,
one extension shelf,
three extension doors
and cable cut-out



Entertainment



40 Sideboard
W/D/H: 1523/373/740 mm
with two drop-down doors

41 Low media unit
W/D/H: 3023/523/430 mm
with four drop-down doors
and castors



42 Sideboard
W/D/H: 1523/373/565 mm
with two drop-down doors



43 Low media unit
W/D/H: 1523/373/430 mm
with two drop-down doors
and castors



44 Low media unit
W/D/H: 2273/523/390 mm
with two drop-down doors,
one flip-up door
and one divider shelf



45 Side table
W/D/H: 773/373/565 mm
with one drop-down door



Enjoy the peace and relax.

A bedroom is a place to relax, to recharge – your sanctuary. With its sheer simplicity, USM design helps you to ease your mind – offering enough variations to create your own personal sense of calm.



Bedroom



47 Storage unit
W/D/H: 773/525/1265 mm
with one extension door,
two drop-down doors and
two drawers

48 Storage unit
W/D/H: 2273/373/890 mm
with nine extension doors



49 Storage unit
W/D/H: 2273/523/565 mm
with three extension doors
and six drawers



50 Storage unit
W/D/H: 1523/523/915 mm
with six extension doors
and four drawers



51 Storage unit
W/D/H: 773/373/915 mm
with two drop-down doors,
two divider shelves,
one extension door with
box insert

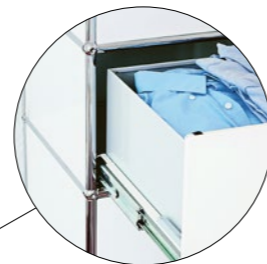

Spacious drawers
Discover the full
range of smart
organisational
elements — p. 71.

Bedroom



↙
52 Side table
 W/D/H: 523/373/565 mm
 with one drop-down door

→
53 Side table with built-in USM Haller E lighting*
 W/D/H: 523/373/565 mm
 with one drop-down door
 *with a dimmable cold or warm white light

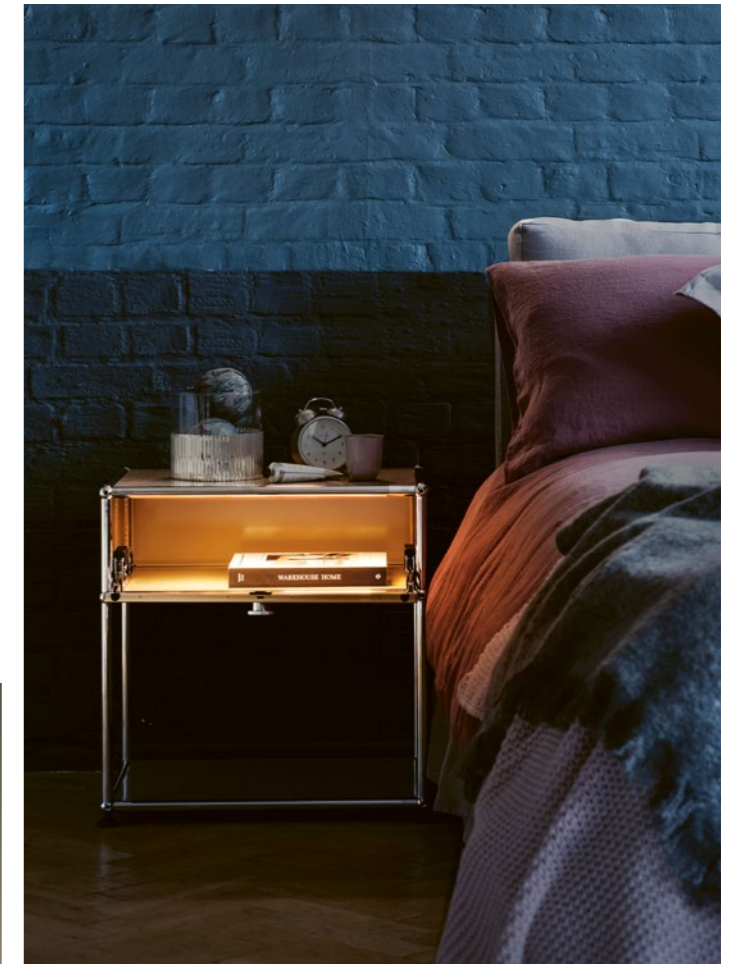

USB chargers transform the furniture into a charging station for your mobile devices.



54 Side table
 W/D/H: 773/373/840 mm
 with two drop-down doors



55 Storage unit
 W/D/H: 1023/373/565 mm
 with two drop-down doors



56 Side table
 W/D/H: 773/373/740 mm
 with one drop-down door



57 Side table
 W/D/H: 523/373/565 mm
 with one drop-down door

A playful start to grow into a great future.

Why not add a bit of colour to your design? USM Haller marks a playful spot in your children's room. It serves as a toy box, a bookshelf or storage. A sustainable companion, growing with your children as their needs change.



- ↙ 58 Shelving
W/D/H: 3273/373/2140 mm
with ten drop-down doors
- 59 Toy box
W/D/H: 373/373/390 mm
- ↘ 60 Toy box
W/D/H: 523/523/430 mm
with castors



-  61 Desk with toy box
W/D/H: 1273/523/580 mm
with castors
-  62 Storage unit
W/D/H: 1523/373/1090 mm
with four drop-down doors
-  63 Low storage unit
W/D/H: 2023/373/390 mm
with four drop-down doors

Kids

- ↙ 64 Shelving
W/D/H: 2273/723/740 mm
with one drop-down door
- 65 Sideboard
W/D/H: 773/373/740 mm
with one drop-down door



Shelving

Beauty and function from all sides.

USM Haller gives you the choice – and endless design possibilities. Deliberately showcase your treasured pieces: as room-dividing eye-catchers freestanding in the open space – or discreetly fitted into any niche.

66 Shelving
W/D/H: 2973/373/1965 mm
with four drop-down doors,
two flip-up doors,
four extension doors
with one box insert
and cable cut-out



Shelving

- ↙ 67 Shelving
W/D/H: 2273/373/1940 mm
with six drop-down doors
- 68 Shelving
W/D/H: 1418/373/2915 mm
with four drop-down doors



Shelving



69 Shelving
W/D/H: 2273/373/1440 mm
with three drop-down doors
and three extension doors

70 Shelving
W/D/H: 3273/373/1965 mm
with three drop-down doors
and one flip-up door



With our configurator you
can playfully create your own
individual furniture.
www.usm.com



71 Shelving
W/D/H: 3023/373/2140 mm
with one drop-down door



72 Shelving
W/D/H: 3523/373/1790 mm
with ten drop-down doors



73 Shelving
W/D/H: 3773/373/2140 mm

Shelving



↙ 74 Glass showcase with built-in USM Haller E lighting*
W/D/H: 3773/373/915 mm with ten glass doors
*with a dimmable cold or warm white light

↓ 75 Shelving with built-in USM Haller E lighting*
This piece has special dimensions, our sales partners will be happy to advise you.
*with a dimmable cold or warm white light

↓ 76 Side table
W/D/H: 523/418/475 mm with castors

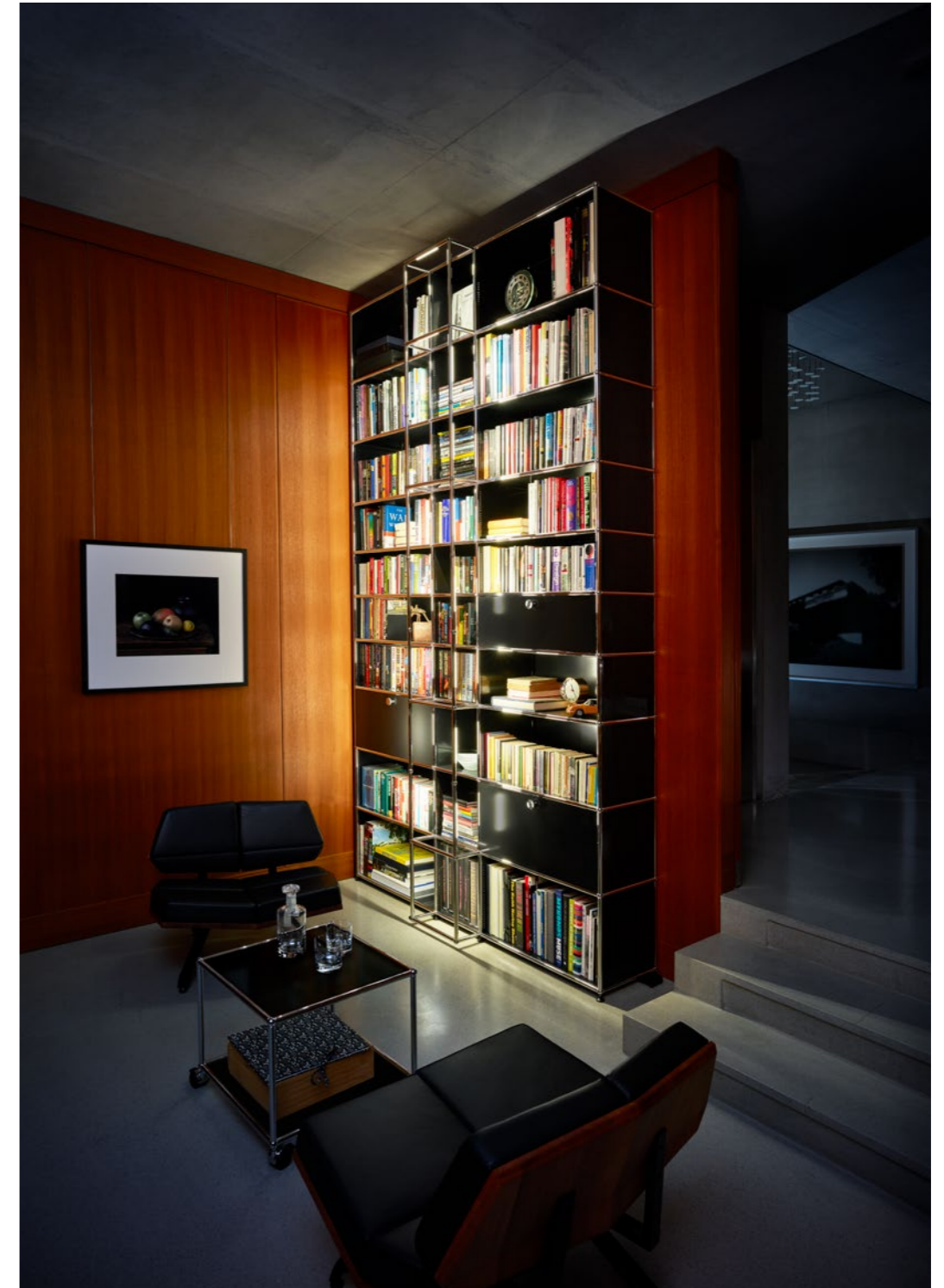

Shelving

↙
77 Shelving
W/D/H: 1418/373/1065 mm
with two drop-down doors
and two extension doors
with box inserts

→
78 Shelving
W/D/H: 2523/373/2290 mm
with eleven drop-down doors
and four glass doors



Storage

Our versatility with an unassuming face.

Thanks to its modularity and timelessness, USM fits into every environment, fulfilling a wide range of functions within your home. It adapts to your needs and taste. And it helps you organise your home, offering all the storage space you need – wherever you want it.



↙
79 Mobile pedestal
W/D/H: 773/523/755 mm
with one drop-down door,
two extension doors,
one box insert and castors

→
80 Shelving
W/D/H: 523/373/1590 mm
with three extension doors
and box insert



81 Sideboard
W/D/H: 1523/373/890 mm
with two extension doors

82 Shelving
W/D/H: 773/373/1090 mm
with three drop-down doors

83 Mobile pedestal
W/D/H: 523/373/605 mm
with three extension doors,
box insert and castors



Organising trays
Discover the full
range of smart
accessories —
p. 71.

Storage



84 Shelving
W/D/H: 2273/373/1790 mm
with four drop-down doors
and two extension doors

85 Shelving
W/D/H: 5523/523/2640 mm
with two drop-down doors,
twelve flip-up doors
and twenty extension doors
with ten box inserts



86 Sideboard
W/D/H: 1523/723/915 mm
with six drop-down doors
and six extension doors



87 Glass showcase
W/D/H: 1023/373/1340 mm
with two drop-down doors
and two glass doors

Storage



↙
88 Wardrobe
 W/D/H: 2873/1273/2190 mm
 with six drop-down doors,
 four extension doors with
 box inserts and a clothes rail

→
**89 Wardrobe with built-in
 USM Haller E lighting***
 W/D/H: 1623/373/1440 mm
 with two drop-down doors,
 a clothes rail and plant panels
 with a world of plants
 *with a dimmable cold or
 warm white light



90 Wardrobe
 W/D/H: 1523/523/1265 mm
 with seven extension doors
 with box insert
 and a clothes rail



91 Wardrobe
 W/D/H: 773/373/1915 mm
 with two extension doors with
 box insert and a clothes rail



92 Wardrobe
 W/D/H: 2723/1473/1790 mm
 with one drop-down door,
 four extension shelves and
 one extension door with box
 insert and two divider shelves
 and three clothes rail

Storage

93 Shelving
This piece has special dimensions, our sales partners will be happy to advise you.



Storage



↙
94 Shelving
W/D/H: 1023/373/815 mm
with two drop-down doors

↓
95 Wardrobe
W/D/H: 1523/373/1440 mm
with three drop-down doors



↘
96 USM Inos drawer set
Available in all 15 USM colours.



Design your individual
piece of USM online!
www.usm.com

Feel at home while you work at home.

The home office is a natural part of modern working life. An inspiring environment is not only stylish but enhances well-being and productivity. USM adds quality to the workplace in your home – and to your life at large.

97 Desk
W/D/H: 2623/523/1090 mm
with three drop-down doors
and one extension shelf



Home office



↙
 98 Shelving
 W/D/H: 773/373/1790 mm
 with two drop-down doors,
 one divider shelf and one
 extension door with box insert

→
 99 Shelving
 W/D/H: 773/373/1090 mm
 with two drop-down doors,
 one extension door with
 box insert and cable cut-out



100 Shelving
 W/D/H: 1523/373/1090 mm
 with four extension doors
 with filing frames



101 Mobile pedestal
 W/D/H: 1023/373/605 mm
 with four drop-down doors
 and castors



102 Shelving
 W/D/H: 3523/373/1790 mm
 with thirteen drop-down doors

103 USM Haller desk,
 rectangular
 L/D/H: 1500/750/740 mm
 Pearl grey laminate

104 Shelving with built-in
USM Haller E lighting*
W/D/H: 3773/373/2090 mm
with a world of plants,
four drop-down doors and
two extension doors
*with a dimmable cold or
warm white light

105 USM Haller table,
rectangular
L/D/H: 2000/750/740 mm
Black linoleum



Home office



- ↙
106 Sideboard
W/D/H: 1523/373/740 mm
with four drop-down doors and
two USM Inos drawer sets
- 107 Desk
W/D/H: 1168/523/740 mm
with one drop-down door



108 Shelving
W/D/H: 773/373/1790 mm
with two drop-down doors



109 Sideboard
W/D/H: 1523/373/740 mm
with two drop-down doors
and two extension doors
with filing frames



110 Shelving
W/D/H: 773/373/1440 mm
with two drop-down doors



111 Desk
W/D/H: 1273/523/740 mm
with two drop-down doors

- 112 Shelving
W/D/H: 2023/373/1440–2390 mm
with three drop-down doors,
two glass doors and a world of
plants
- 113 USM Kitos M,
height adjustable
L/D/H: 1750/750/700–1200 mm
Linoleum Pebble
- 114 Mobile pedestal
W/D/H: 418/523/605 mm
with three drawers and castors



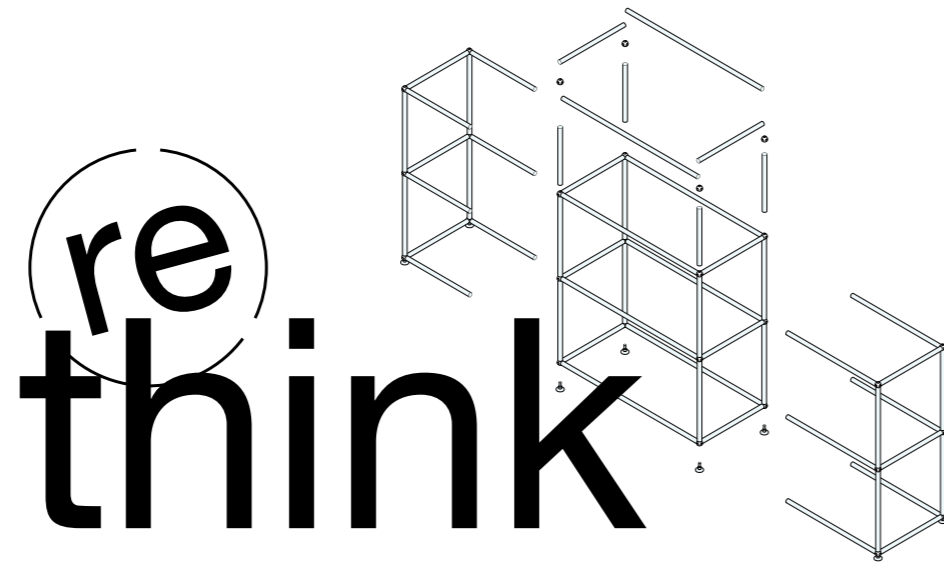

Rethink, redesign, revalue sums up the sustainable benefit of our products.

What and how much do you really need? What purposes should a piece of furniture serve? Experienced consultants and virtual planning tools enable us to support you to create a bespoke and conscious purchase. So that you get exactly what you really need, tailored to your current requirements. But don't worry, once furniture has been designed, it can always be rethought and adapted to new circumstances.

Each piece is unique, planned and assembled especially for you. Our furniture is designed to be forever reconfigured. Thanks to the high-quality finish and clever design, all components can be change and extended at any time without any problems. This leads to limitless creative freedom, more individuality in design and almost infinite cycles of use.

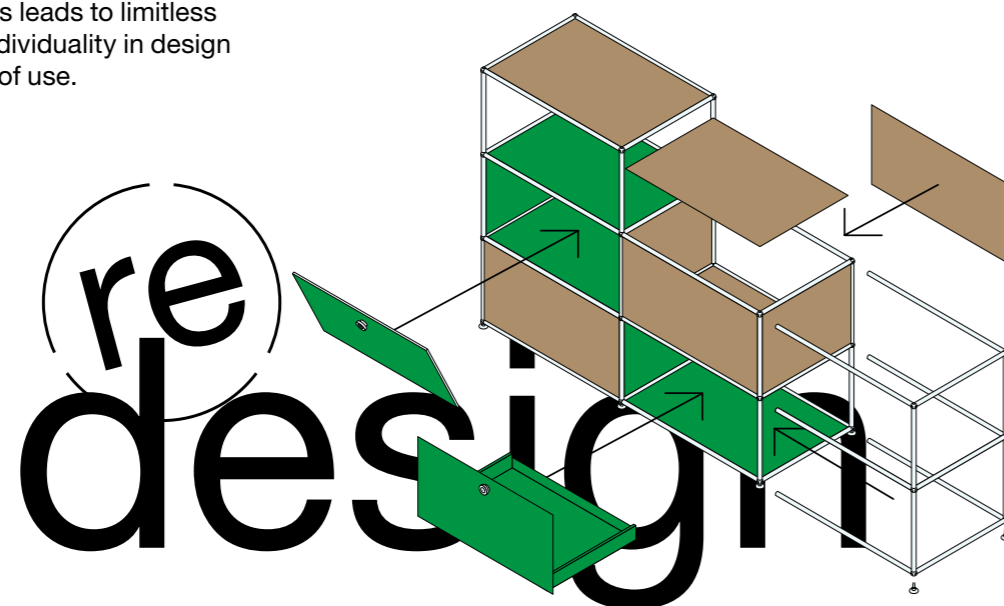

Our vision – becoming a fully circular business
We want to extend circularity principles beyond our products. That means adopting this philosophy throughout our company – from our product development to our manufacturing, and new business models, from our communications to our supply chain, operations and the expertise of our people.

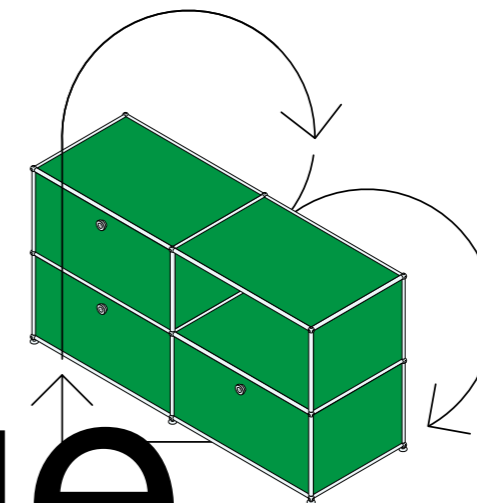

Thanks to the high quality, colours that never fade and a 100% modular system, decades-old USM furniture can be seamlessly combined and upgraded with new components. We believe a product that adapts to your style, your life, your changing needs is relevant and loved.

USM furniture is a valuable companion for life, across generations.



Our product lines USM Haller and USM Kitos M, accounting for more than 92% of our revenue, carry the Cradle-to-Cradle® certification. It is the leading multi-attribute standard used globally across industries for designing and making products that enable a healthy, fair and sustainable future according to the world's most advanced science-based measures.



All our four main product lines carry the UL Green-guard Certification for low chemical emission. Having undergone rigorous scientific testing to meet stringent emissions requirements, this certification approves that our products contribute to a healthier indoor air quality.



DRIVING AMBITIOUS CORPORATE CLIMATE ACTION



We have committed to set the following emission reductions in line with the latest climate science:

- Reduction of absolute direct and indirect greenhouse gas emissions (scope 1 and 2) by 42% by 2030 from a 2021 base year.
- Reduction of other absolute indirect greenhouse gas emissions (scope 3) by 25% within the same timeframe.

(Our target boundary includes land-related emissions and removals from bioenergy feedstocks.)

The Science Based Targets initiative (SBTi) has approved USM's above near-term science-based emissions reduction targets. The highly respected climate action organisation, partnering with renowned organisations including the United Nations Global Compact and the World Wide Fund of Nature (WWF), enables companies worldwide to play their part in combating the climate crisis.



Learn more at

www.usm.com/sustainability

USM Haller

The USM Haller system provides a wide variety of elements in standard sizes. Widths, depths and heights are indicated below. All measurements refer to the distance between axes.



Your safety matters to us. Check out the USM safety instructions now. www.usm.com/safety

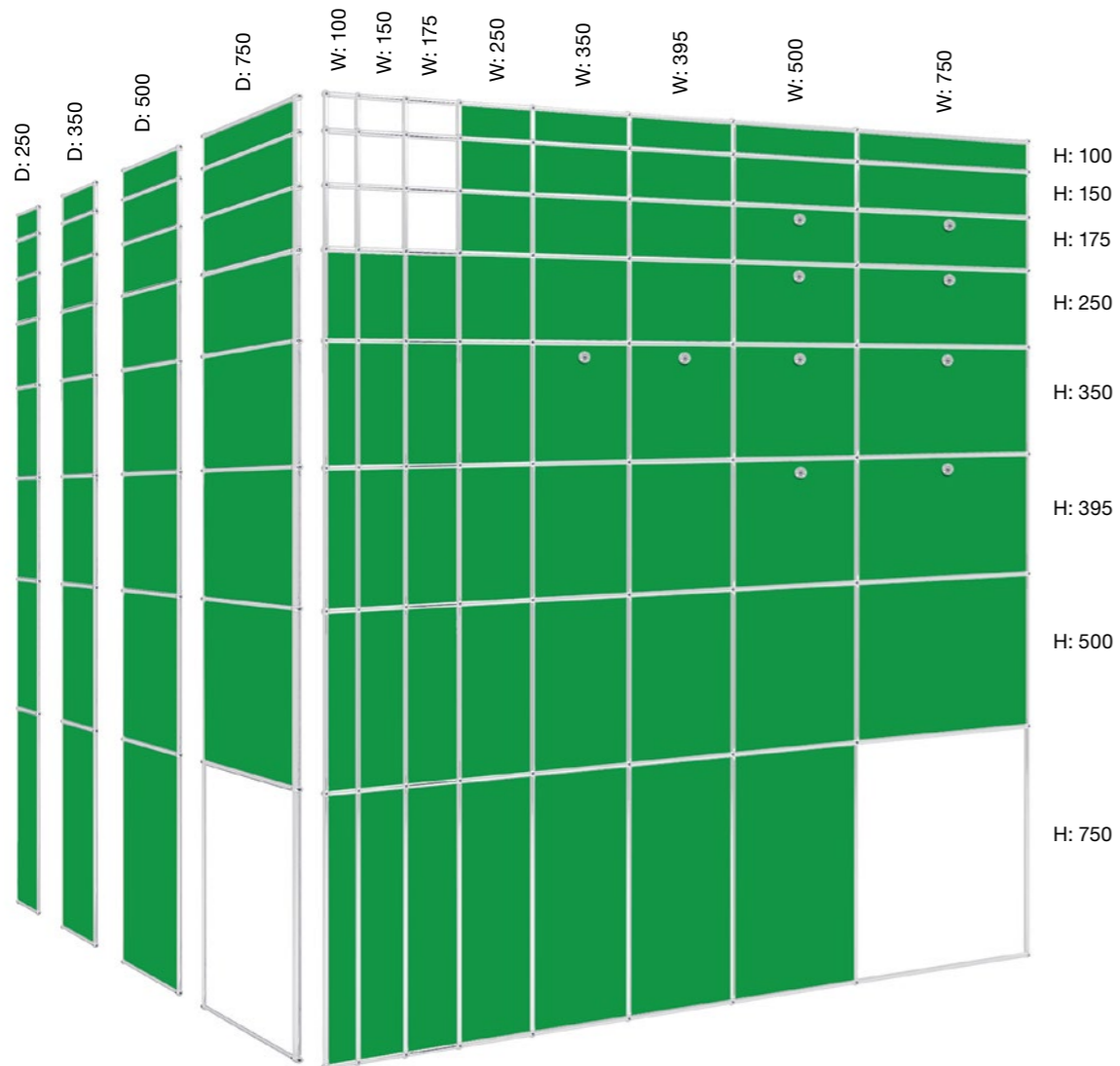
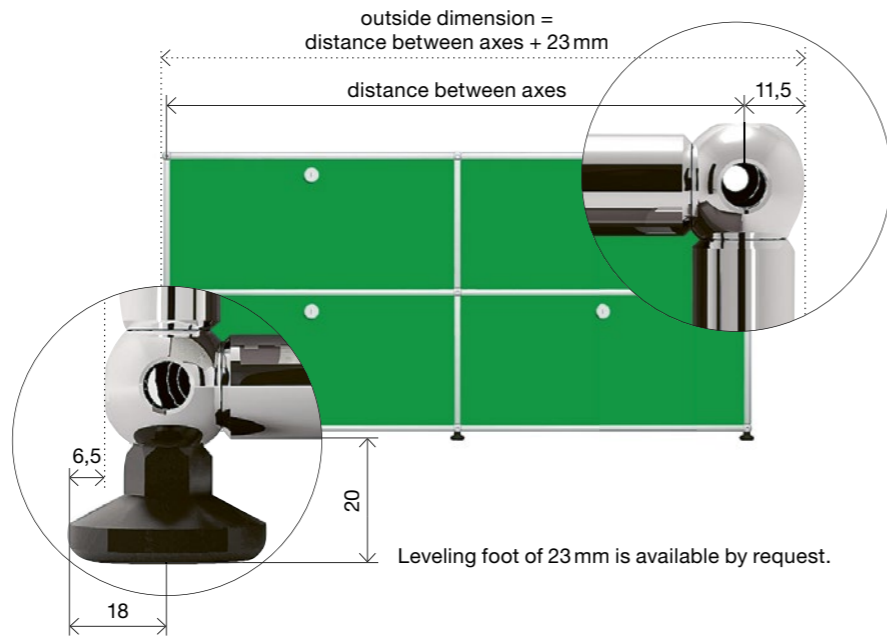

All measurements in mm.

Panels

- 1 Metal panel
- 2 Glass panel
- 3 Acoustic panel
- 4 Perforated metal panel

Doors

- 5 Metal flip-up door*
- 6 Glass door
- 7 Acoustic drop-down door
- 8 Metal drop-down door
- 9 Metal extension door*

Shelves and drawers

- 10 Metal divider shelf
- 11 Glass divider shelf
- 12 Metal extension shelf
- 13 Metal angled shelf
- 14 Extension filing set with extension shelf
- 15 Small drawer D: 500
- 16 A6 drawer D: 500
- 17 A5 drawer D: 500
- 18 A4 drawer D: 500
- 19 Metal plant panel with circular recesses to hold the pots

Accessories

- 20 Hanging file baskets
- 21 Metal box insert
- 21a Slide profile for metal box insert
- 22 Cable cut-out
- 23 Metal magnetic bookend
- 24 USM Inos box
- 25 USM Inos DVD tray
- 26 USM Inos CD tray
- 27 USM Inos angled file trays
- 28 Bookend for bookshelf panel (D: 350)
- 29 USM Inos, drawer set, open
- 30 USM Inos, drawer set, closed
- 31 USM Inos drawer organiser set

Start configuring your individual piece of USM now! www.usm.com



Illustration: USM Haller in D: 500 mm.

*Acoustic version available. All measurements in mm.

USM Haller E

A modular structure of your design, either completely or partially equipped with e-Balls and e-Tubes, is connected to a source of electricity. The structure itself conducts the low voltage electricity to the desired location using the e-Balls, e-Connectors and e-Tubes to form a circuit. USB chargers or light sources can be snapped into place in pre-cut recesses. The power supply is drawn from any point near the ground. The power supply cable is attached to an e-Ball, and the power adapter is subsequently tucked underneath the furniture until only the operating switch remains visible. From this point the power supply requires no further cables but rather is integrated into the structure of the furniture.

Application options

- 1 **Glass panel**
Glass elements can be illuminated throughout.
- 2 **Without metal paneling**
Compartments without metal paneling can be completely illuminated.
- 3 **With metal paneling**
Compartments with metal paneling can be illuminated from the front.
- 4 **Compartment with an extension shelf**
The entire compartment with an extension shelf can be illuminated.
- 5 **Drop-down and extension door**
Via the "Light When Compartment Is Open" function, the light automatically turns on when the door is opened.
- 6 **Angled shelf**
The presentation space is illuminated from the front.
- 7 **Floor lighting**
With floor lighting, the light shines at a 25-degree angle under the furniture.
- 8 **Ambient lighting**
The light is directed vertically towards the back, illuminating the surroundings with a warm glow.
- 9 **e-USB charger**
It can be integrated in the same places as the e-Lights.

e-Elements

- 1 **e-Lights**
Dimmable, available in
– Warm white 2700 Kelvin
– Cold white 5700 Kelvin
Both with or without the "light at compartment opening" function.
- 2 **e-USB charger**
Provides a voltage of 5 volts to the connected device. (Capacity: 6.5 W)
- 3 **e-Dummy**
Sleek, black e-Dummy element, closes recesses that are unutilised. Can be changed for additional e-Lights or e-USB charger later.
- 4 **e-Tube (power outlet)**
Tubes with recesses for e-Lights, e-USB chargers or e-Dummy elements that can be easily snapped into place or replaced.

L 350, 1 recess
L 500, 2 recesses
L 750, 3 recesses
- 5 **e-Tube (conductive)**
The conductive e-Tube serves to conduct the electricity if no inserts are desired in this location. It is available in lengths of 750, 500, 395, 350, 250 and 175 mm.
- 6 **e-Ball, e-Connector**
To enable the flow of electricity, the ball and connector were refined. The exterior dimensions remain unchanged. The distinguishing feature of the ball is the black insulation ring.
- 7 **e-Power supply**
Includes dimmer at the operating switch. Transforms the power supply voltage to 24 volts. (Capacity: 60 W)

CE

Engineered & Made in Switzerland.

Only available in certain countries. Please contact USM Switzerland for availability in your country.



GERMAN DESIGN AWARD WINNER 2019

Winner of the German Design Award 2019 for outstanding design quality in the Office Furniture category



Winner of the Wallpaper® Design Awards 2018



Winner of the Focus Gold Award 2018 for outstanding design quality



Winner of the Muuz International Award 2018 in the furniture category



Winner of the FX Design Awards, Lighting Product 2017

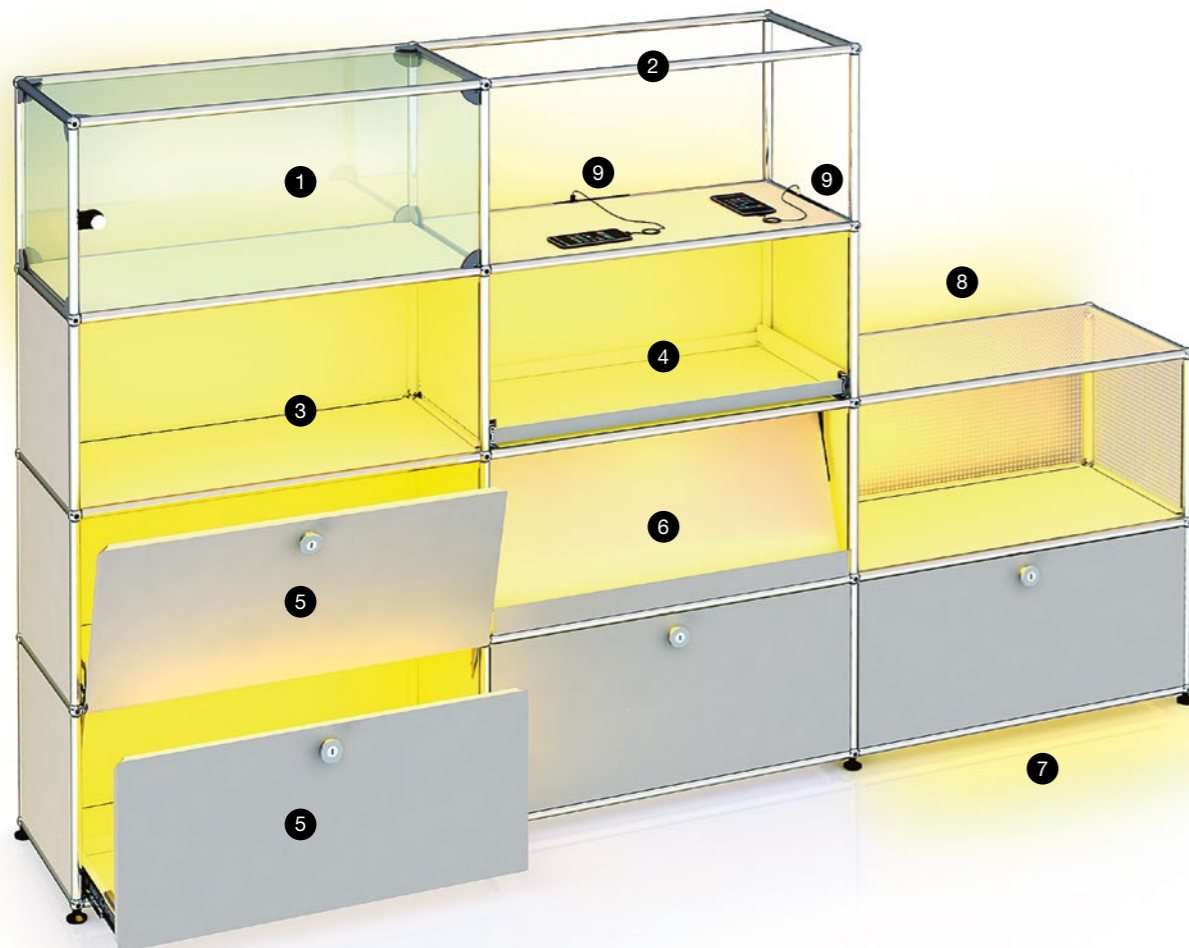

USM Haller table

The USM Haller and USM Haller Plus desk can be equipped with an optional cable basket, while the USM Haller Advanced features integrated smart solutions for electrification. All desks can be equipped with grommet hatches for network access.

Basic table

Optional cable basket underneath the tabletop



USM Haller

H: 740
L: 3000 / D: 1000
L: 3000 / D: 750
L: 2500 / D: 1000
L: 2500 / D: 750
L: 2250 / D: 1000
L: 2250 / D: 750
L: 1000 / D: 1000
L: 750 / D: 750
L: 1250 / D: 500**

H: 740 or 680-860*
L: 2000 / D: 1000
L: 2000 / D: 750
L: 1750 / D: 1000
L: 1750 / D: 750
L: 1500 / D: 1000
L: 1500 / D: 750
L: 1250 / D: 750

Sliding tabletop + adaptation points

Integrated cable tray accessible from above by sliding back the tabletop
Adaptation points for accessories



USM Haller Advanced

H: 740 or 680-860*
L: 2000 / D: 1000
L: 2000 / D: 750
L: 1750 / D: 1000
L: 1750 / D: 750
L: 1500 / D: 1000
L: 1500 / D: 750
L: 1250 / D: 750

Working desk

Optional cable basket underneath the tabletop
Removable adaptation points for accessories



USM Haller Plus

H: 740
L: 3000 / D: 1000
L: 3000 / D: 750

H: 740 or 680-860*
L: 2000 / D: 1000
L: 2000 / D: 750
L: 1750 / D: 1000
L: 1750 / D: 750
L: 1500 / D: 1000
L: 1500 / D: 750
L: 1250 / D: 750

Side table



USM Haller Side table

H: 370
L: 3000 / D: 1000
L: 3000 / D: 750
L: 2500 / D: 1000
L: 2500 / D: 750
L: 2250 / D: 1000
L: 2250 / D: 750
L: 2000 / D: 1000
L: 2000 / D: 750
L: 1750 / D: 1000
L: 1750 / D: 750
L: 1500 / D: 1000
L: 1500 / D: 750
L: 1000 / D: 1000
L: 750 / D: 750

* Optional manual height adjustment with a removable handle.

**Only available in the surfaces pearl grey laminate, black linoleum and Fenix, Grigio Londra
All measurements in mm.

Accessories for all USM Haller desks

- 1 **Grommet hatch for network access**
Hatch for a single power outlet, flushmounted in tabletop. This unit can be mounted in two different positions on the tabletop.
- 2 **Cable management**
For the Advanced table, a cable tray integrated under the tabletop offers storage room and attachment options for all cables and technical components. For the USM Haller Plus, a cable wire basket can be attached.
- 3 **CPU holder**
Computers in various sizes can be mounted using a simple holding device under the table.
- 4 **Link chain**
Holds and directs cables to the power source. Flexible and adjustable to different lengths.
- 5 **Flat screen support arm**
Screens are mounted onto the support arm (VESA standard). Swivel-type with a spherical joint for the screen. Mounting at different heights is possible for screens weighing up to 12 kg.
- 6 **Flat screen pivot arm**
Screens are screwed to the height adjustable pivot arm using a mounting plate (VESA standard). Continuous height adjustment for screens weighing up to 12 kg.
- 7 **Front and side panel**
Can be attached under the table to the long side or laterally. For tables with lengths: 2000, 1750, 1500, 1250 and depths: 1000, 750.
- 8 **Pivoting pen holder**
Provides room for writing instruments and can be discreetly stowed under the tabletop.
- 9 **USM Privacy Panels**
Fitted on the long side of the table to provide individualisation and privacy. H: 350 or H: 700. For tables with lengths: 3000, 2000, 1750, 1500.
- 10 **Handle**
With slip clutch for synchronous height-adjustment (optional).

Accessories for USM Haller Plus / Advanced desk

- 11 **Flat screen support bar**
The support bar is inserted into the adaptation points. Up to two screens (max. 2 x 12 kg) can be attached using a mounting plate (VESA standard). Screens can be mounted at different heights; screens can be adjusted with ball joints. Continuously height-adjustable for screens weighing up to 12 kg.
 - 12 **USB adapter**
The adapter is suitable for USB 2.0 and 3.0 ports. It can easily be inserted into the adaptation point. Usable as power supply or for data transfer.
 - 13 **Lamp peg**
An optional lamp peg for easy attachment of selected table lamps. Electrification is possible through the adaptation point.
- Options
- 11a **Flat screen support bar fix**
 - 11b **Flat screen support bar adjustable**
Move forwards or backwards two notches at a time to adjust the viewing distance.



All measurements in mm.

USM Kitos M and E desk

Each desk of the USM Kitos M and E family offers integrated smart solutions for electrification, excluding free-standing.

Why USM Kitos M?

The "M" in its name stands for mechanical spring-loaded height adjustment; adjustment time approx. 1 second with zero energy consumption. This system is more than 10 times faster than the electronic equivalent and has an extremely long operating life.

Why USM Kitos E?

Maximum functionality and captivating design – USM Kitos E unites all requirements in one modern workplace: continuous height adjustability and maximum stability. A distinction is made between fixed and motor-driven legs in the E1, E2 and E3 models.

E1



H: 740
With or without middle traverse

E2 with 1 motor



H: 700–1200
Adjustment time approx. 30 sec.
With middle traverse

E3 with 2 motors



H: 650–1300
Adjustment time approx. 20 sec.
With middle traverse

Basic desk

Integrated cable tray underneath the tabletop



USM Kitos M

H: 700–1200
L: 1800 / D: 900
L: 1750 / D: 750
L: 1600 / D: 800

USM Kitos E

L: 1800 / D: 900
L: 1750 / D: 750
L: 1600 / D: 800
Available with E1*, E2 or E3** columns

Sliding tabletop

Integrated cable tray accessible from above by sliding back the tabletop

Adaptation points for accessories



USM Kitos M Plus

H: 700–1200
L: 1800 / D: 900
L: 1750 / D: 750
L: 1600 / D: 800

USM Kitos E Plus

L: 1800 / D: 900
L: 1750 / D: 750
L: 1600 / D: 800
Available with E1*, E2 or E3 columns

Extra size

Integrated cable tray underneath the tabletop and accessible from all sides



USM Kitos M Meeting

H: 700–1150
L: 2500 / D: 1000
L: 2250 / D: 1000

USM Kitos E Meeting

L: 2500 / D: 1250
L: 2500 / D: 1000
L: 2250 / D: 1000
Available with E1, E2 or E3 columns

Side table



USM Kitos E Free-standing

H: 740 or 700 – 1110
Square
L: 750 and 900
Round
Ø: 900 and 1100

The table can also be provided with an asymmetrical version of the middle traverse, for extra legroom. (This is not possible with the USM Kitos E / M Meeting.)

* Available with or without middle traverse.

** Available in a GS-Mark tested version with 3 mm table edge radius and the asymmetrical middle traverse.

All measurements in mm.

Accessories for all USM Kitos M and E desks

- Grommet hatch for network access**
Hatch for a single power outlet, flush-mounted in table-top. This unit can be mounted in two different positions on the tabletop.

- CPU holder**
The CPU holder allows computers of various sizes to be mounted either under the tabletop facing outwards or on the middle traverse facing outwards or inwards as desired.

- Link chain**
Holds and directs cables to the power source. Flexible and adjustable to various lengths.

- USM Privacy Panels**
Fitted on the long side of the table to provide individualisation and privacy.
H: 350 or 700.
For tables with lengths: 2500, 2250, 1800, 1750, 1600.

Accessories for all USM Kitos M and E desks, except USM Kitos M Meeting / E Meeting

- Flat screen pivot arm**
Screens are screwed to the height adjustable pivot arm using a mounting plate (VESA standard). Available for USM Kitos E and M tables: the pivot arm is mounted onto the tabletop using the universal support. Available for USM Kitos M and E Plus: The pivot arm can be inserted into one of the adaptation points with a tube set. Continuous height adjustment for screens weighing up to 12 kg.

- Front panel**
Can be attached under the table to the long side or laterally. For tables with lengths: 1800, 1750, 1600.
- Material tray**
Provides room for writing instruments and can be discreetly stowed under the tabletop.

Accessories for USM Kitos M Plus / E Plus

- Flat screen support arm**
Screens are mounted onto the support arm (VESA standard) which can be connected directly to one of the adaptation points. Swivel-type with a spherical joint for the screen. Mounting at different heights is possible for screens weighing up to 12 kg.
- Flat screen support bar**
The bracket is inserted into the adaptation points. Up to two screens (max. 2 x 12 kg) can be attached using a mounting plate (VESA standard). Screens can be mounted at different heights; screens can be adjusted with ball joints.

- Options:
- Flat screen support bar fix**
 - Flat screen support bar adjustable**
Move forwards or backwards two notches at a time to adjust the viewing distance.
 - USB adapter**
The adapter is suitable for USB 2.0 and 3.0 ports. It can easily be inserted into the adaptation point. Usable as power supply or for data transfer.
 - Lamp peg**
An optional lamp peg for easy attachment of selected table lamps. Electrification is possible through the adaptation point.

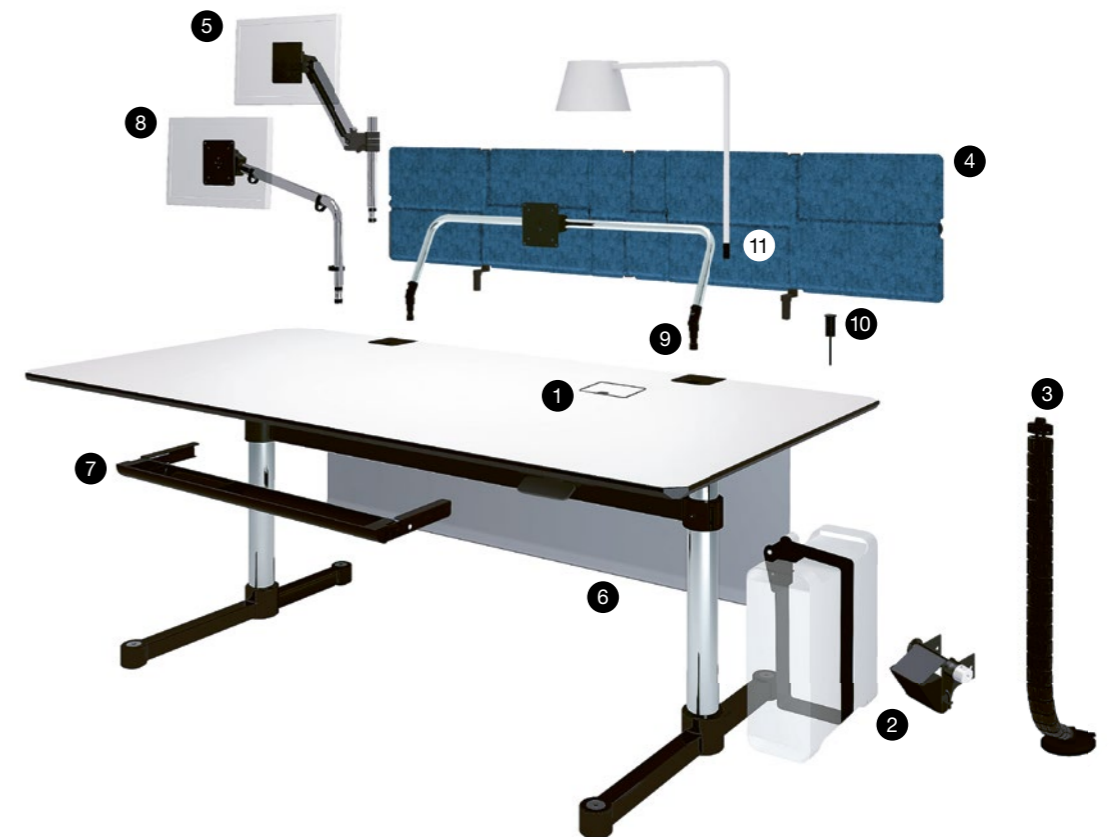

All measurements in mm.

Accessories



1



2

1 Metal magnetic bookend
Available in light grey and graphite black.

2 Pivoting pen holder
Provides room for writing instruments and can be discreetly stowed under the tabletop.

3 USM Inos internal organisation
Plastic inserts in metal trays are ideal for storing small bits and pieces, whether in the home office or in the house.

4 USM Inos drawer set
Thanks to its dimensions it fits into any piece of USM furniture. The displayed set with 5 closed drawers is avail-

able in all **15 USM colours**. The drawer sets with 5 open, 10 open or 10 closed drawers are available in graphite black and pure white.

5 USM Inos Box
The new USM Inos Boxes organise, store and protect both your treasures and everyday bits and pieces. Several boxes can be stacked on top of each other with the help of trays, which can also be used as covers or serving trays, or to hold assorted small items around the home. These soft storage boxes made of nonwoven polyester are available in four different sizes and in light grey and anthracite grey.

6 World of plants for USM Haller
Lively evergreen landscapes can now be easily integrated into the structure of USM Haller.



6



3



4



5



Colours & surfaces

USM Haller



Metal



Pure white RAL 9010
Light grey RAL 7035



USM matte silver
USM mid-grey



Anthracite RAL 7016
Graphite black RAL 9011



Steel blue RAL 5011
Gentian blue RAL 5010



USM green
Golden yellow RAL 1004



Pure orange RAL 2004
USM ruby red



USM brown
USM beige



Olive green RAL 6003

USM Haller and USM Kitos tables



Powder-coated MDF



Pure white RAL 9010

Transparent glass



Transparent glass

Linoleum

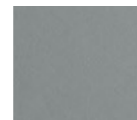

Ash linoleum



Charcoal linoleum



Black linoleum

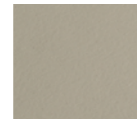

Pebble linoleum

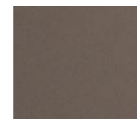

Mauve linoleum

Laminate



Pearl grey laminate



Pastel grey laminate



Light mid-grey laminate



Dark warm grey laminate

Fenix



Fenix, Bianco Kos

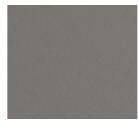

Fenix, Grigio Londra



Fenix, Nero Ingo

Oiled or lacquered veneer

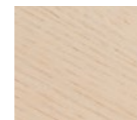

White oiled oak veneer

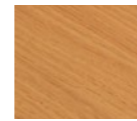

Natural oiled oak veneer

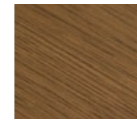

Brown oiled oak veneer



Natural lacquered oak veneer

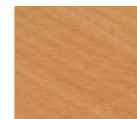

Natural lacquered beech veneer

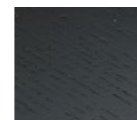

Black lacquered oak veneer

USM Privacy Panels



Fabric panel



Light grey

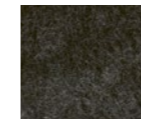

Anthracite



Blue



Green



Yellow

USM Inos box



Fabric panel



Light grey



Anthracite

USM Inos drawer set



Metal



Pure white RAL 9010



USM matte silver



Anthracite RAL 7016



Steel blue RAL 5011



USM green



Pure orange RAL 2004



USM brown



Olive green RAL 6003



Light grey RAL 7035



USM mid-grey



Graphite black RAL 9011



Gentian blue RAL 5010



Golden yellow RAL 1004



USM ruby red



USM beige

Pots



Clay

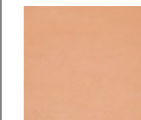

Terracotta

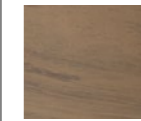

Basalt

Details

USM Haller



Metal

USM Haller table

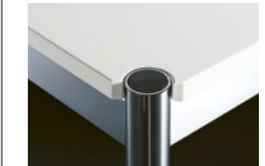

Powder-coated MDF

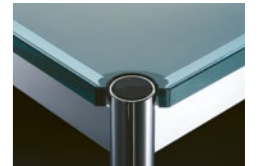

Transparent glass



Linoleum



Laminate

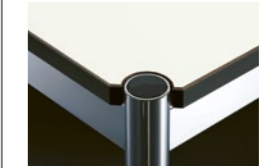

Fenix



Oiled or lacquered veneer

USM Kitos table



Powder-coated MDF



Transparent glass



Linoleum



Laminate



Fenix

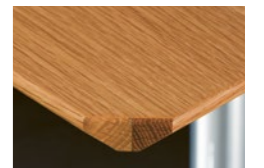

Oiled or lacquered veneer

The tabletop in glass is only available for USM Haller desks up to L: 2000mm and all USM Kitos desks with a fixed height (H: 740mm) or step-wise height adjustment and continuous height adjustment (H: 680-780 / 1060mm).

Other colours and surfaces available upon request.

Prices and delivery times of table surfaces upon request.

The following options are available in graphite black and pure white only: USM Inos drawer set, 5 drawers, open USM Inos drawer set, 10 drawers, closed USM Inos drawer set, 10 drawers, open



03.2024, en, 1700



Switzerland

USM U. Schärer Söhne AG
Thunstrasse 55, 3110 Münsingen
Phone +41 31 720 72 72, info.ch@usm.com

Germany

USM U. Schärer Söhne GmbH
Siemensstraße 4a, 77815 Bühl
Phone +49 7223 80 94 0, info.de@usm.com

France

USM U. Schärer Fils SA, Showroom
23, rue de Bourgogne, 75007 Paris
Phone +33 1 53 59 30 37, info.fr@usm.com

United Kingdom

USM U. Schaerer Sons Ltd., London Showroom
Ground Floor, 49–51 Central St., London, EC1V 8AB
Phone +44 207 183 3470, info.uk@usm.com

USA

USM U. Schaerer Sons Inc., New York Showroom
28–30 Greene Street, New York, NY 10013
Phone +1 212 371 1230, info.us@usm.com

Japan

USM U. Schaerer Sons K.K., Tokyo Showroom
Marunouchi MY PLAZA 1 · 2F
2-1-1 Marunouchi, Chiyoda-ku, Tokyo 100-0005
Phone +81 3 6635 9420, info.jp@usm.com

All other countries
contact USM Switzerland.

www.usm.com



USM creative at home