

DATASHEET

Type: **STARCLOUD**
Name: Pendant light
ID: PC1344
Designed by: Lucie Koldová



Download

Description

These stars project a subtly different optical effect depending on the viewing angle, appearing to variably wax and wane or come to rest in a state of symmetry. Suspended on slender coaxial cables of varying lengths, the delicate handblown glass shades are available in three variants: opaque opaline, pearl pink opaline, and pearl grey opaline.



Tech. description

The light comprises a dural fixture with integrated LED module, a diffuser crafted from light-conducting material, and a glass shade. The light is suspended on a coaxial cable from a metal ceiling canopy.

CONSTRUCTION SPECIFICATION

Weight: 1.9 kg
Construction material: glass, metal
Cord length [mm]: 2,200 mm
Mounting: Ceiling
Environment: Indoor

DIMENSIONS [mm]

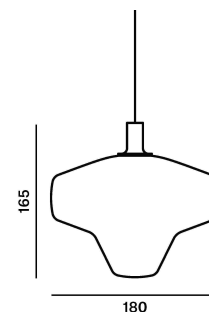

ELECTRICAL SPECIFICATION

Input voltage [V]: 100 - 240 V
Frequency [Hz]: 50-60 Hz
Max. power [W]: W
Coverage IP: 20
Socket: -
Light source: LED module
Energy class: E

CERTIFICATIONS



BROKIS®

BROKIS S.R.O.
ŠPANILOVA 1315/25
163 00 PRAHA 6 - ŘEPY
CZECH REPUBLIC

ORG ID 64940799
VAT ID CZ64940799
C 42174 MĚSTSKÝ SOUD
V PRAZE

TEL +420 567 211 517
TECHNICAL@BROKIS.CZ
INFO@BROKIS.CZ
WWW.BROKIS.CZ

2024_02
PAGE 1



CM17826

Type	LED module
Lamp wattage [W]	2,5 W
Input voltage [V]	24 VDC
Energy class	E
Flux [lm]	250 lm
Light colour [K]	2700 K
CRI	90+
Dimmable	yes



INNER FIXTURE

Dimensions O x w [mm] 80 X 165 mm
Weight [kg] 1 kg
Material metal

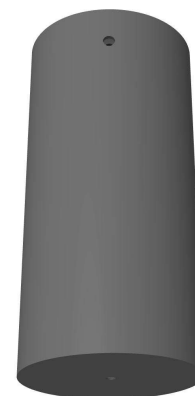

Drawing

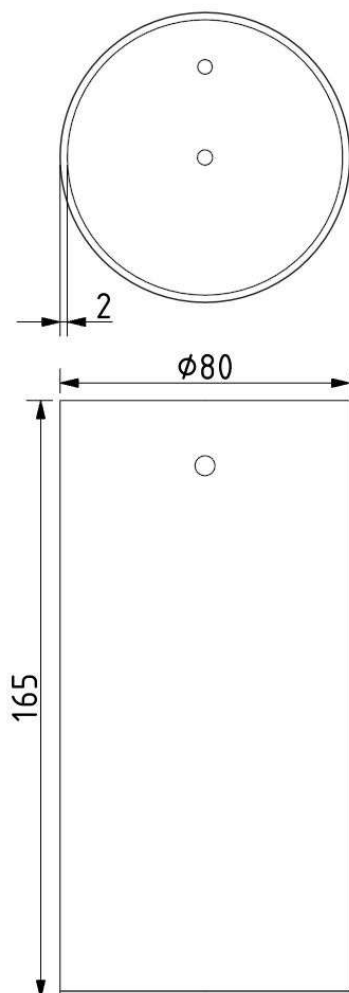

Hole placement

